

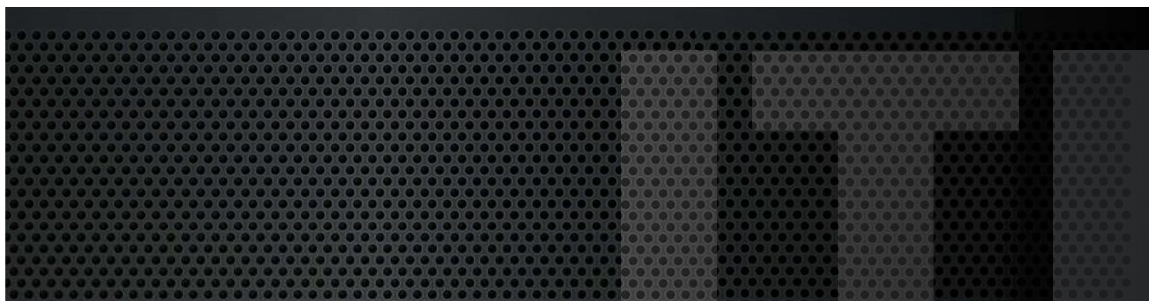

Solutions
in motion

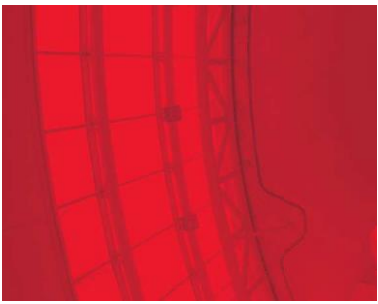

TELESCOPIC – **INGROUND** INSTALLATION GUIDE



Product presentation



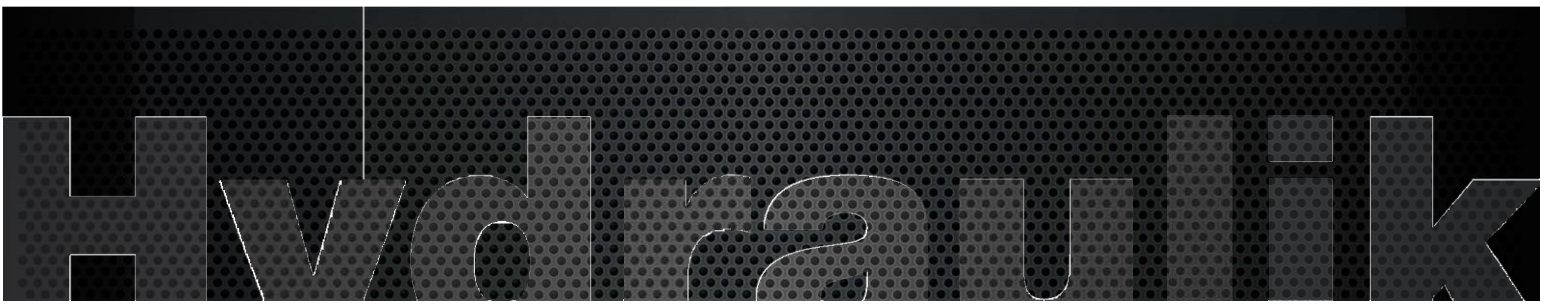

Tables of contents

Product presentation	2
Technical drawing – Head	4
Technical drawing – Bottom	6
Product characteristics	8
In-ground telescopic jack installation	9
Air bleeding and synchronization	10
Followers guides	11
Maintenance program	12
Check valve replacement	14
Pit Channel Installation	16
Warranty Policy	18

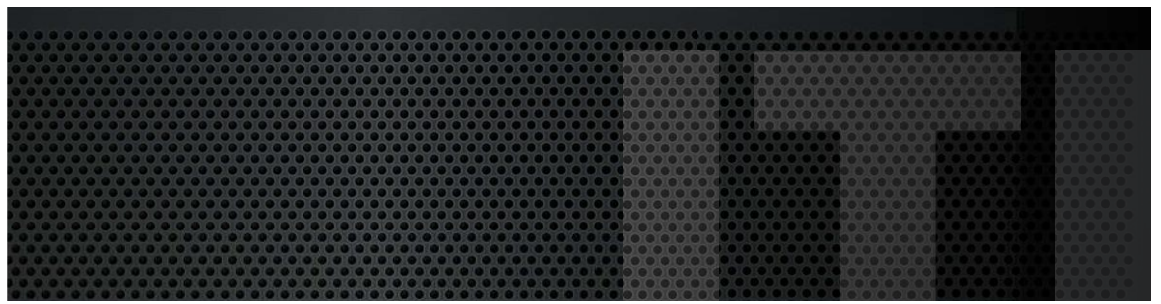
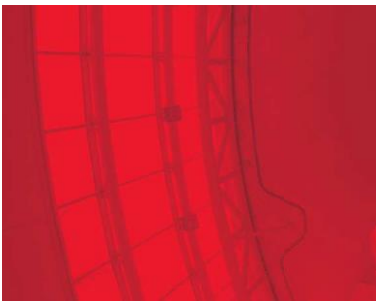

Technical drawing – Head

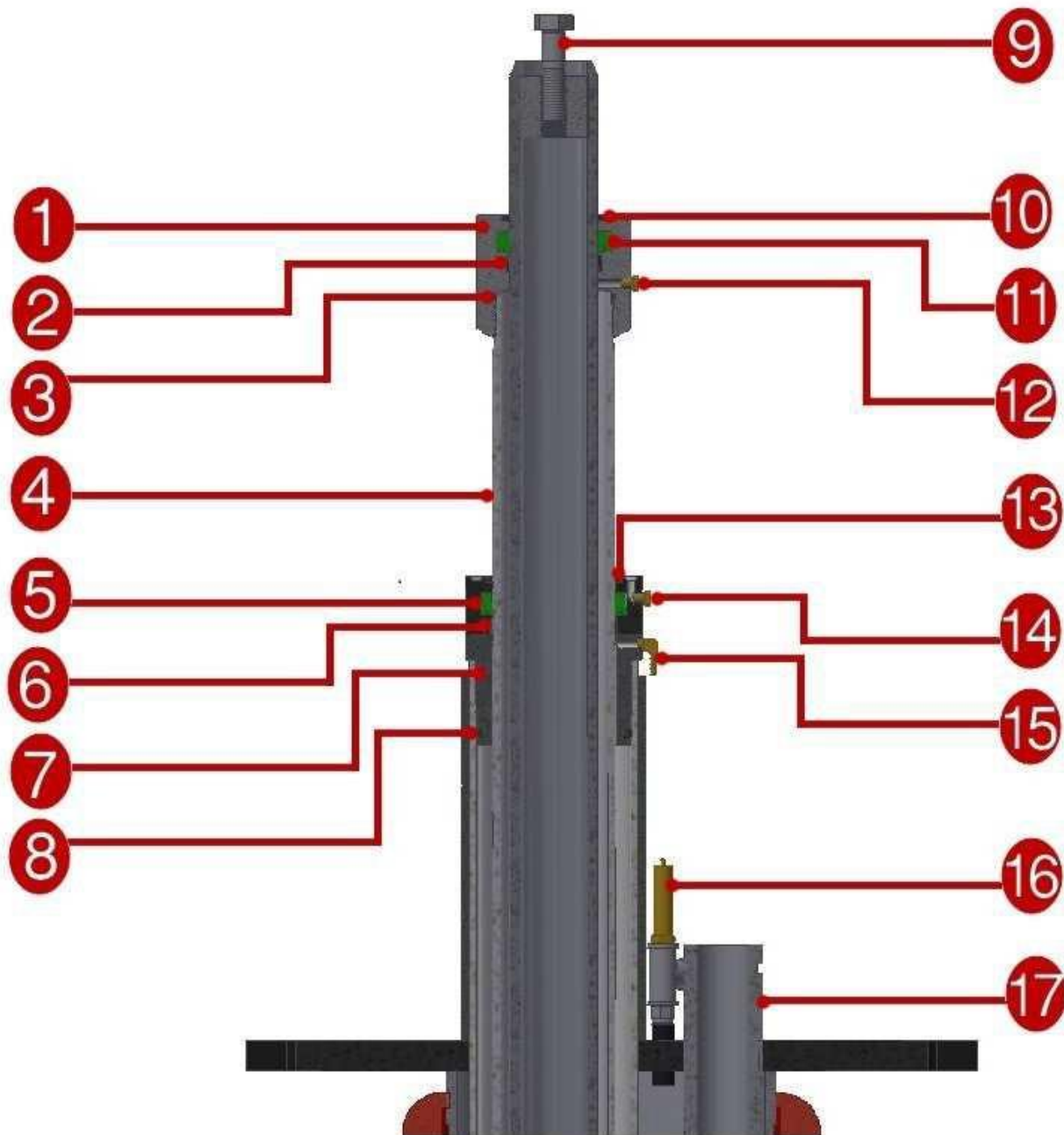

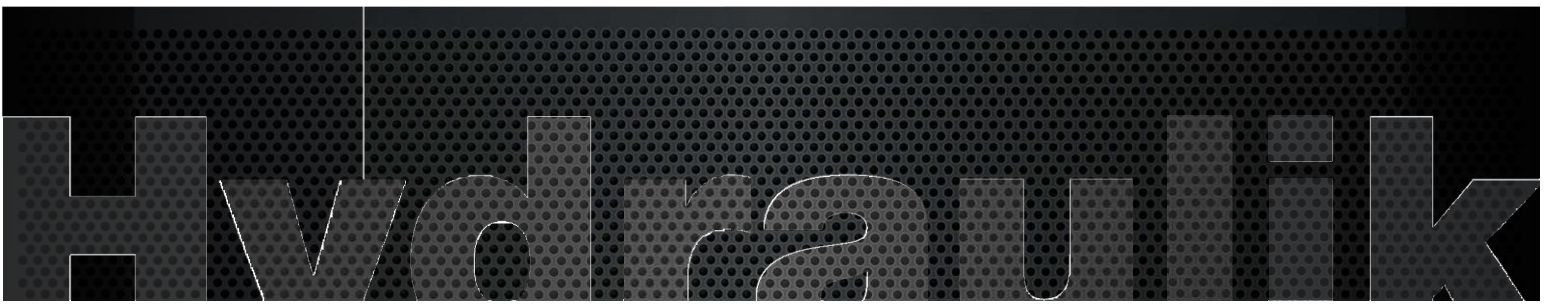
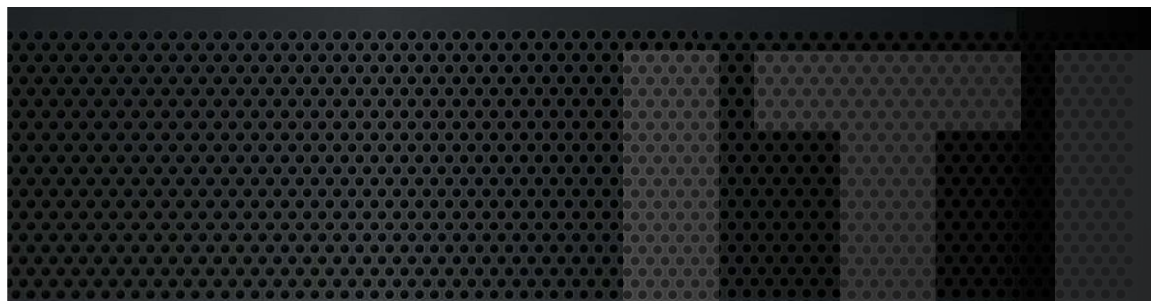
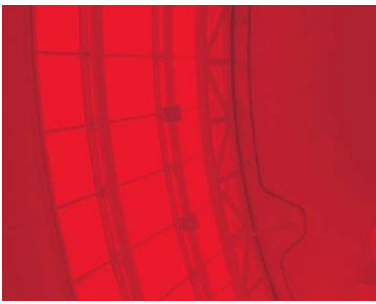

Table of components - Head

#	Components	Materials
1	Head (1 st section)	Cast Iron
2	Wear ring (1 st section)	Nylon
3	O'ring (1 st section)	Buna-N
4	Tube or shaft (1 st section)	Steel
5	Seal (2 nd section)	Urethane
6	Wear ring (2 nd section)	Nylon
7	Head (2 nd section)	Urethane
8	O'ring (2 nd section)	Buna-N
9	Bolt	Steel
10	Wiper (1 st section)	Urethane
11	Seal (1 st section)	Urethane
12	Bleeder (1 st section)	-
13	Wiper (2 nd section)	Urethane
14	Bleeder (2 nd section)	-
15	90° coupling (2 nd section)	-
16	Drainage valve	Steel
17	Oil inlet	Steel

If more than 2 sections, the components of the first section repeat for the additional sections.



Technical drawing – Bottom

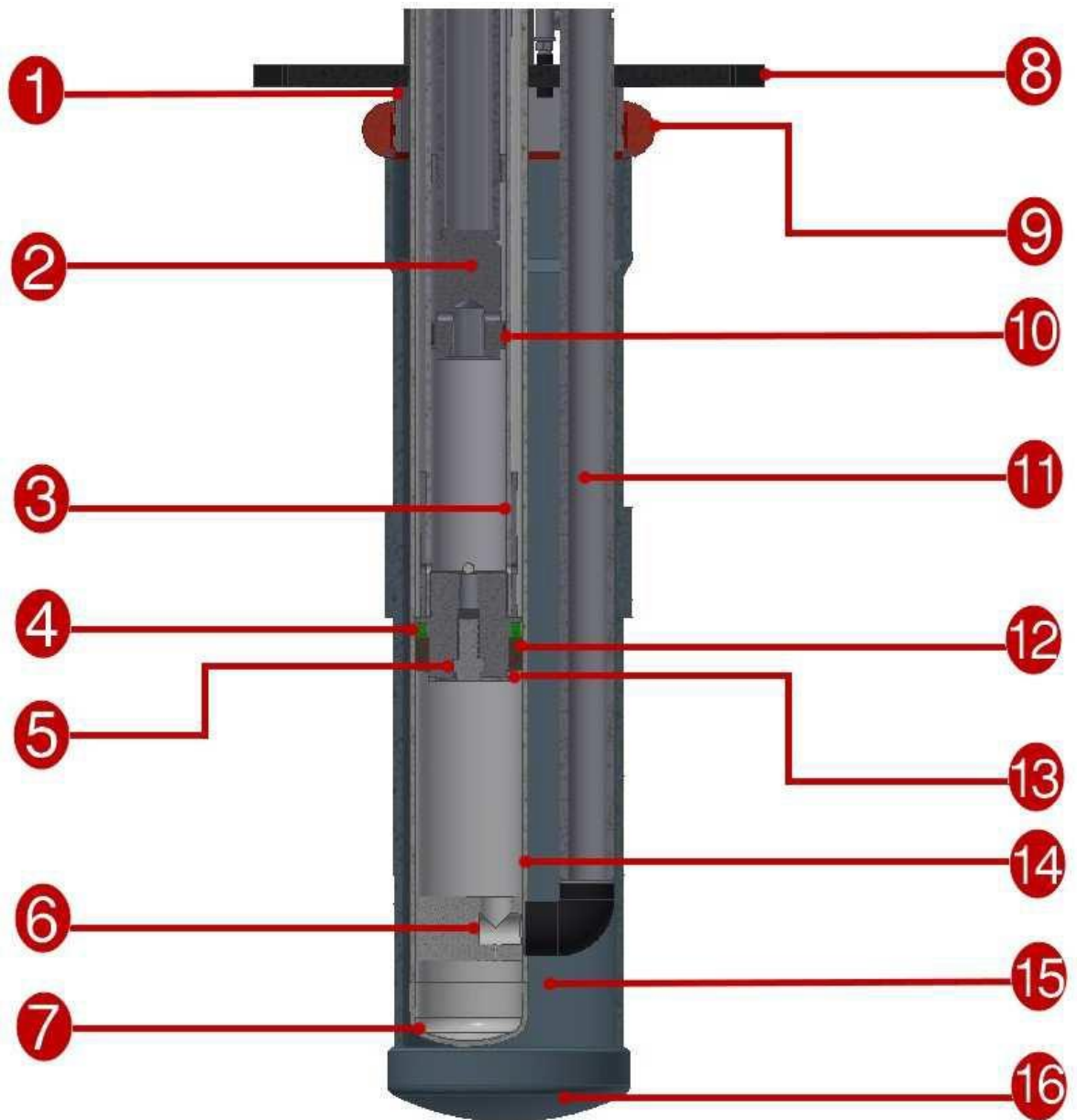

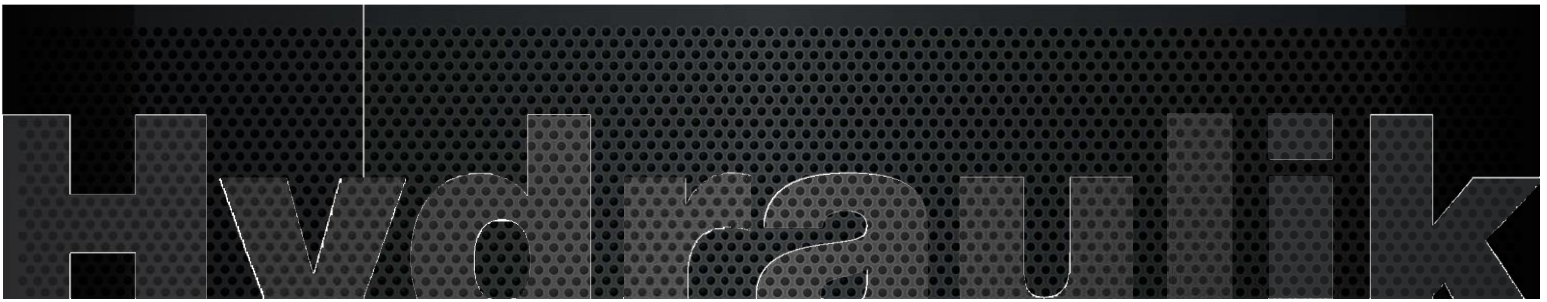
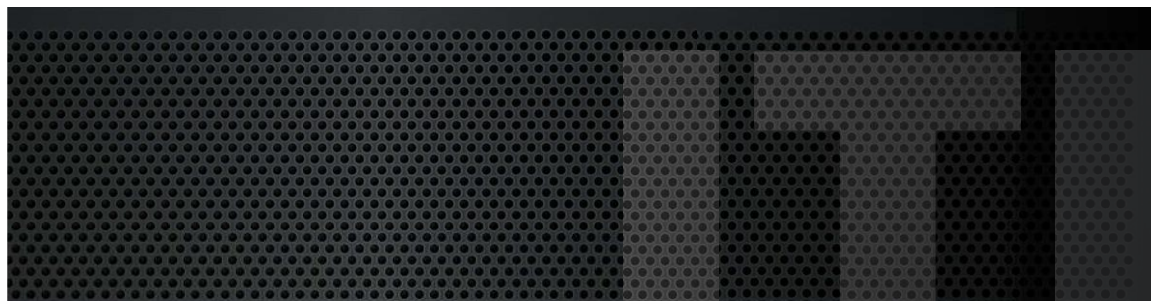
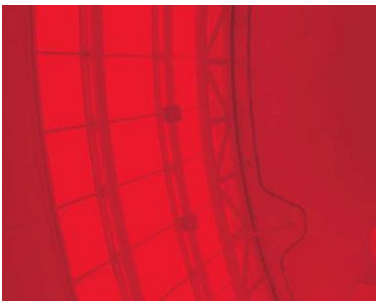

Table of components - Bottom

#	Components	Materials
1	Coupling PVC	-
2	Piston	Cast Iron
3	2 nd (or last) section	Steel
4	Check valve	Steel
5	Seal	Urethane
6	Base	Steel
7	Welding cap	Steel
8	Support	-
9	Victaulic coupling	-
10	Wear ring	Plastic
11	Oil inlet	Steel
12	Bronze piston	Bronze
13	Spirolock	Steel
14	Casing	Steel
15	PVC	Plastic
16	PVC cap	Plastic



Product characteristics

Capacity & standard dimensions

Capacity

Up to 50 000 lbs

1st section

From 1 1/2" to 8"

Number of sections

From 2 to 4

Note Non-standard sizes are available upon request.

Fabrication

Conception and fabrication of the products are in accordance with the CSA B44-13 and ASTM A17.1- 2013 standards.

Our welding procedures are certified according to the CSA W47.1 standard by the Canadian Welding Bureau (CWB).

Scope

- Dumb-waiter lifts
- Lift for disabled people
- Any other utilisation to suit your needs

Further information

Our cylinders are perfectly adapted to any type of elevator (passenger or merchandise).

This cylinder is proudly made in Quebec (Canada) or South Carolina (United States). It can be delivered to the destination of your choice, anywhere in the world.



In-ground telescopic jack **installation**

Hardware

For the cylinder installation

- 1 x Air bleeder (1/8" NPT)
- 1 x Straight coupling for oil return (1/8" NPT)
- 1 x 90° coupling for oil return (1/8" NPT)
- 1 x Clear tubing $\varnothing 3/8"$, 8' longer than the closed length
- 1 x Roll of Teflon tape

Tools

- Buffers
- Bolts

In-ground telescopic cylinder alignment

When the in-ground telescopic cylinder has a first tubular section, an alignment cable is provided to make the installation easier. To install the cylinder correctly, all sections must be in their fully retracted position. To obtain a fully retracted position, the buffers must be removed: they must not have any obstacle limiting this position.

It is important that the actual site conditions are as specified on the layout drawing. Before leaving the job, ensure the total under travel and over travel ratios are specified. Any discrepancy should be noted and corrected before shipping the lift to the customer.

Any small scratches visible on the stages should be polished with very smooth emery (400 grit).



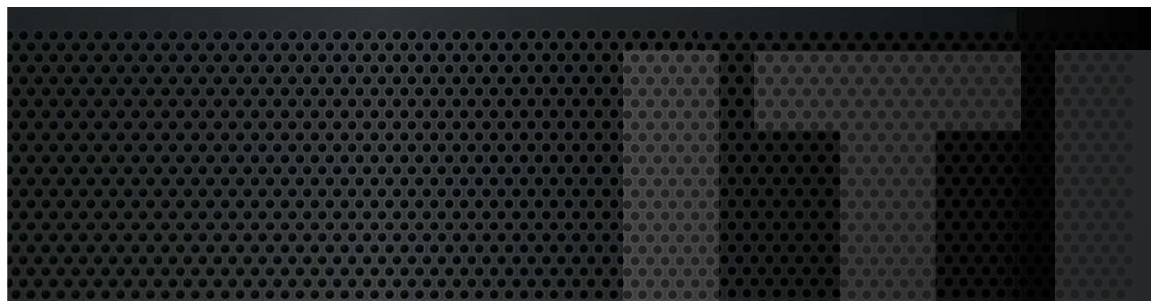
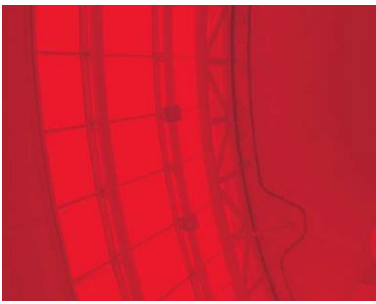

Air bleeding and synchronization

It is possible that at some point your telescopic cylinder is desynchronized. Desynchronization may be caused by leaking seals or a malfunction of the check valve. The venting procedure can resynchronize the telescopic cylinder since it "resets" the distribution of oil volumes between the sections.

INSTRUCTION

WARNING

During all stages, it is important to leave the car attached to the cylinder (s).

To ensure the cylinder functions properly, it is important to evacuate all the air that may be in it by applying the following steps:

1. Remove the buffer stands.
2. Completely close the cylinders using the manual lowering on the valve in the unit.
3. Leave the cylinders completely closed during 1 to 2 minutes to equalize the pressures in each section.
4. Rise the cylinders and the car about 8" per section, enough to make sure there is pressure in each head.
5. Purge the air from each section starting with the 1st section. (Little one at the top)
6. Repeat steps 2 to 5 until the cylinders are synchronized.
7. Run the cylinders 5 to 6 complete strokes (both ascension and descent). If there is air left in the cylinders, the air bubbles will rise in the heads.
8. Open each bleeder (one at a time) starting with the 1st section to make sure there is no more air in the cylinders. If there is air left, repeat steps 2 to 5 until complete removal.
9. Reinstall the buffer stands once all the steps have been applied and your cylinders are well synchronized.

In the case of twin cylinders, poor synchronization can cause oil leaks and/or cabin misalignment. If this procedure does not synchronize the cylinders, please contact our technical department at tech_service@itihydraulik.com. It is possible that the seals or anti-return valves will need to be changed.

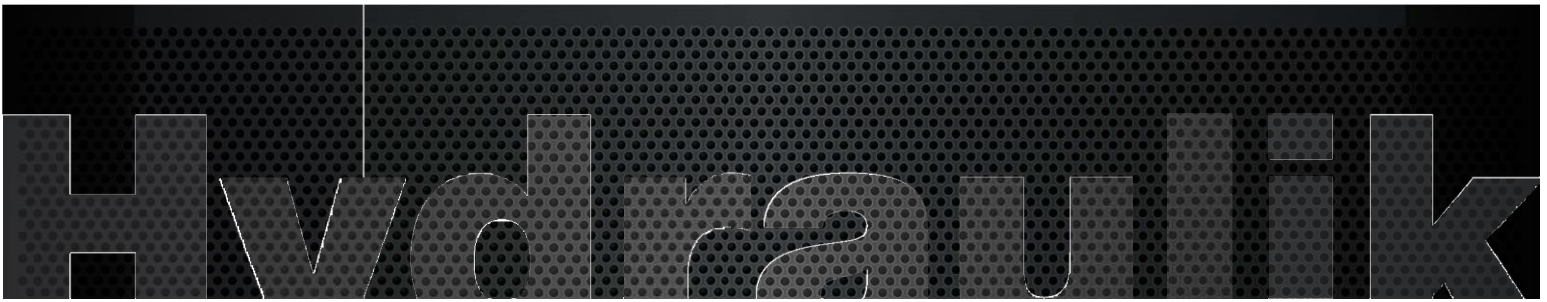

Followers guides

Follower guides provide an additional safety method to prevent buckling of the jack. Its assembly procedure is as follows.

1. Align the cylinder using the information shown previously
2. Install a follower guide on the head of the second biggest section of the jack
3. Repeat the same step for all sections with a smaller diameter
4. Install the car on the jack
5. Install a pair of shoes on each bracket
6. Install brackets on both sides of the follower guides
7. Run the jack up and down a few times
8. Make adjustments, if necessary

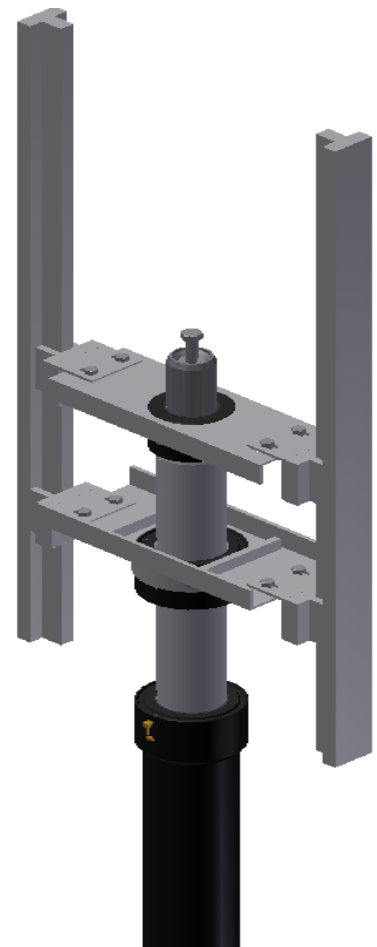

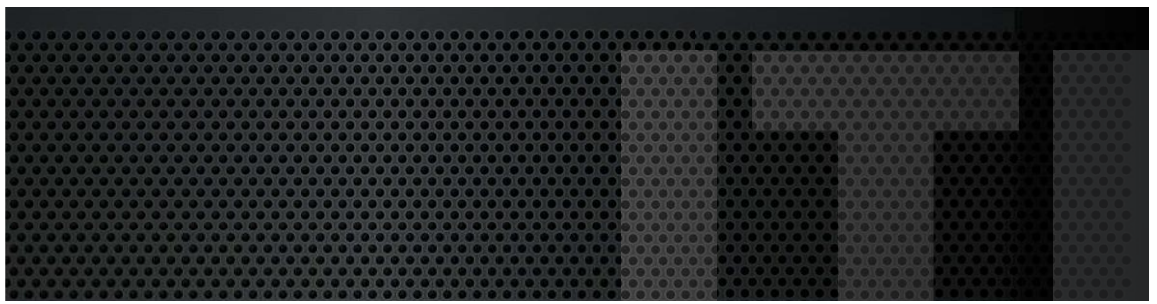
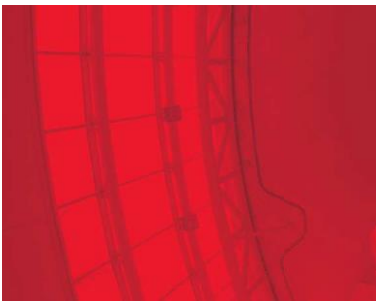

Maintenance program

Monthly verification

- Verify the seals
- Verify the oil level
- Verify the oil quality
- Verify if there are leaks on the line

Note If the seals need to be replaced often, the surface of the piston should be carefully inspected as it can be damaged, wearing the seals prematurely.

Annual verification

- Verify the line strainers
- Verify the piston surface

Seal replacement

1. Lift the cabin up high enough to be able to remove the heads.
2. When the cabin is held securely, turn off the main switch.
3. Unscrew the bolts located above the piston.
4. Open the manual valve (gate valve) until the jack is completely collapsed; there should be no pressure in the jack.
5. Shut off the manual valve (gate valve) to the jack so the oil remains in the reservoir.
6. Open the bleeder on each head.
7. Disconnect the oil recuperator.
8. To facilitate the installation of the heads, mark with a pencil initial position of the head with a line on the head and on the piston.
9. Remove the heads by using two chain vise-grips.
10. Unscrew (CCW) the head while holding the piston with the other chain vise-grip.
11. It is important to put electric tape on the threads of the tubes to prevent damaging the seals when you put them in.
12. Unscrew the brass gland, remove the old joints, put the new ones and lubricate abundantly.
13. Screw back the gland to the maximum without letting any gap between the gland and the head.
14. Re-install the heads and tighten them up to the pencil mark.
15. Bleed the air in the jack, following the steps described in the venting the synchronized telescopic jack section shown previously
16. Re-install the hose to recuperate the oil on the straight or 90° coupling

Note Pay special care to O'rings.

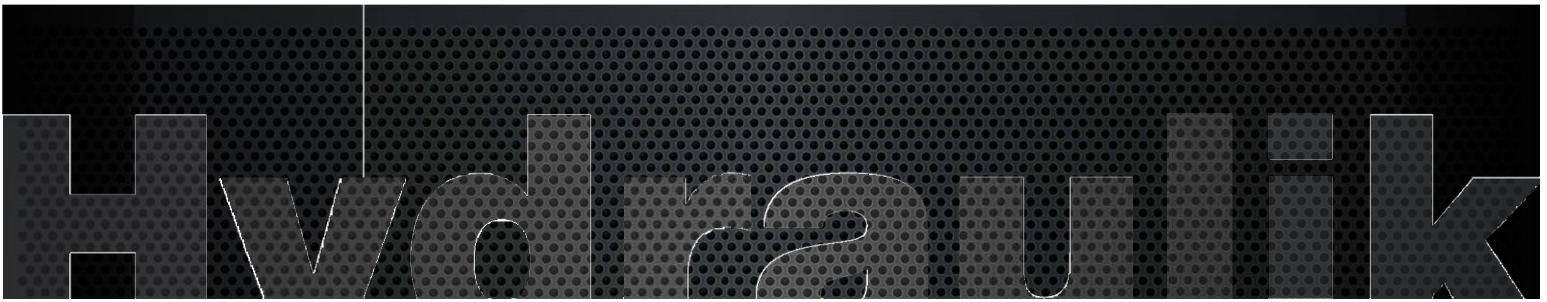

Drainage of PVC coating

The PVC coating protects the cylinder against deterioration due to electrolysis and rust cause by damp and corrosive environment. A condensation builds up at the same inside the PVC coating, so it is very important to drain it regularly.

At the upper end of the rod identified with an “R” on the support plate

1. Remove the square head cap
2. Connect a 1/8 NPT fitting in this inlet
3. Connect the flexible hose (supplied), to the 1/8 NPT fitting
4. Connect it to a recuperation container (5 gallons container)

At the upper end of the rod identified with an “V” on the support plate

5. Screw the fittings to a tee fitting as shown below
6. Connect it to an air pressure device of a maximum 25 PSI
7. Blow until only air comes out of the hose
8. Reinstall the caps



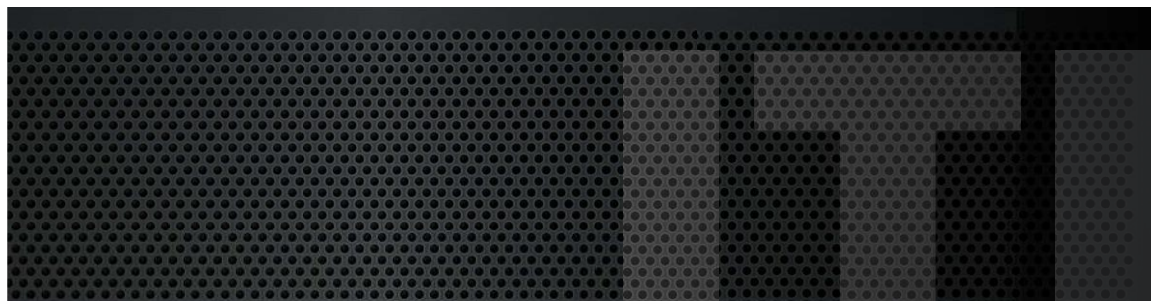
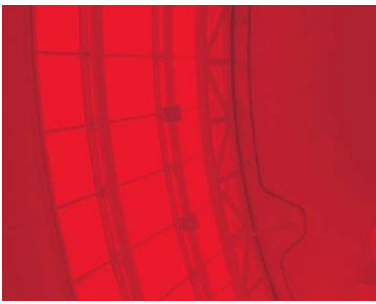

Check valve replacement

The following is the general procedure to change the check valve. These instructions show a 2 sections telescopic jack but the procedure is the same no matter the number of sections.

1. Lift the car up to have enough space to remove the entire section of the jack.
2. When the car is held securely, close the main switches.
3. Unscrew the bolt that holds the piston to the car.
4. Open the manual valve until the piston is fully retracted. There should not be any pressure left in the jack.
5. Close the ball valve on the line leading to the jack to prevent any oil to come from the reservoir.
6. Install a chain block under the car, as centered as possible, and tie the chain around the head of the section where the replacement should be.
7. Remove the bleeder on the head just below and screw the 1/8" NPT fitting connected to a hose. While lifting the upper sections, oil will be ejected through this hose. You can recuperate it in a clean recipient.
8. Lift the previously tied section until the stopper ring reaches the head with the hose. Then, lower the sections of about one inch and unscrew this head. Once the head has been unscrewed, lift the sections until you have enough room to remove the check valve.
9. Remove the check valve by using a 15/16" or 3/4" socket. Some oil will come out this way; recuperate it in a clean recipient.



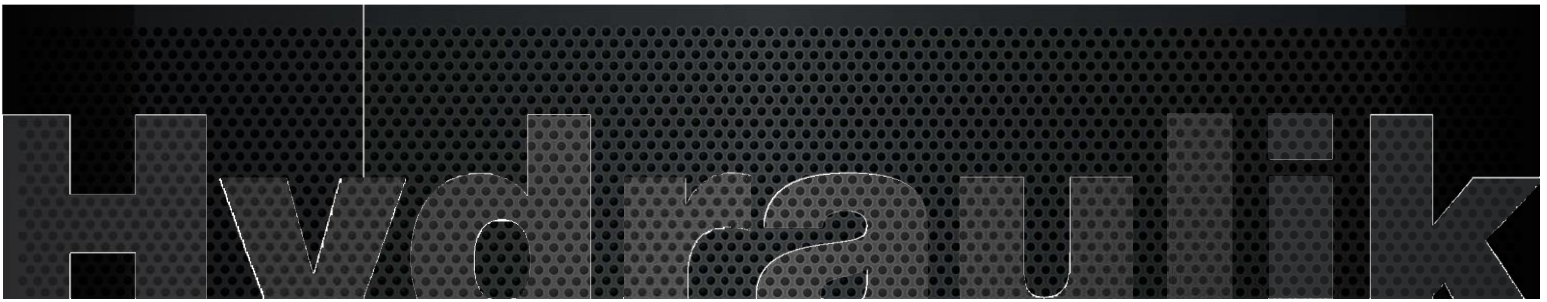

10. Install the new check valve and tighten it well.
11. Verify if the seals have not been damaged and replace them if it's necessary.
12. Insert the sections back in the cylinder and make sure that they are well centered. Screw back the head taken off previously as soon as possible for better alignment. There is no need to screw it very tight at this moment.
13. Just before the jack reaches a completely retracted position, unscrew the same head again to fill the jack with the recuperated oil. Then, screw the head firmly. Another option is simply to put the oil back in the power unit. Do not forget in this case to have the heads firmly screwed. Moreover, a pressure will have to be maintained on the piston to allow the oil to fill the jack.
14. Re-install the bleeder taken off previously.
15. Attach the piston to the car.
16. Follow the procedure described further to resynchronize the jack.

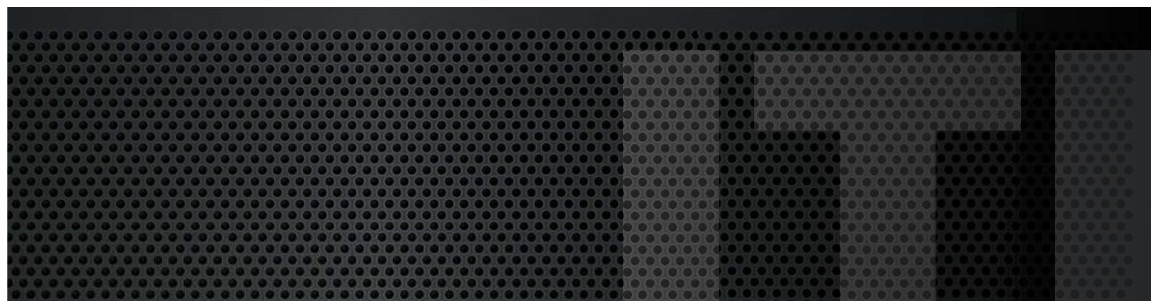
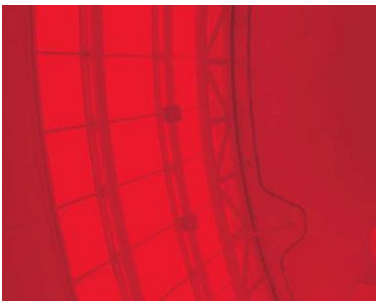

Pit channel installation

Hardware

For the pit channel installation

- 4 Widgets 5/8"
- 4 Bevel washers 5/8"
- 4 spring washers 1/2 "
- 4 Nuts 1/2" NC
- 4 Bolts 1/2" NC et 1 1/2" lg
- 4 Plates 1/2" x 4" x 4"

Options

- Buffers
- Bolts

Tools

- Keys
- Impact wrench

Procedure

1. Install the bolts at the 4 ends of the pit channel
2. Place the levelling plates around the well
3. Place the pit channel above the well on the levelling plates
4. Center the support opening with the well
5. Put the pit channel at grade by using bolts

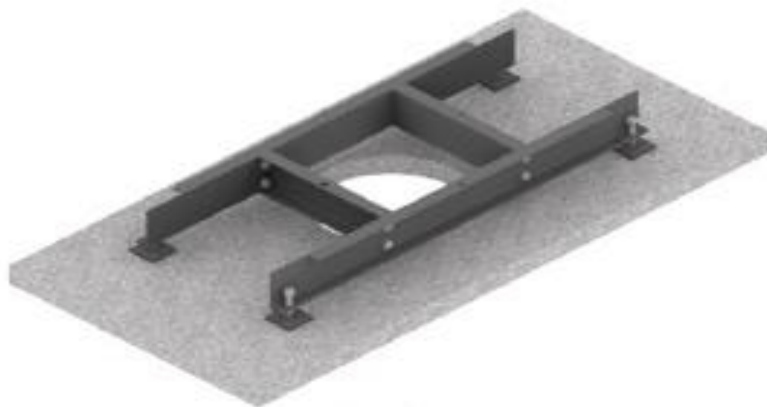

6. Mark the anchors positions
7. Drill the openings for the anchors fixation
8. Assemble the anchors devices on the pit channel

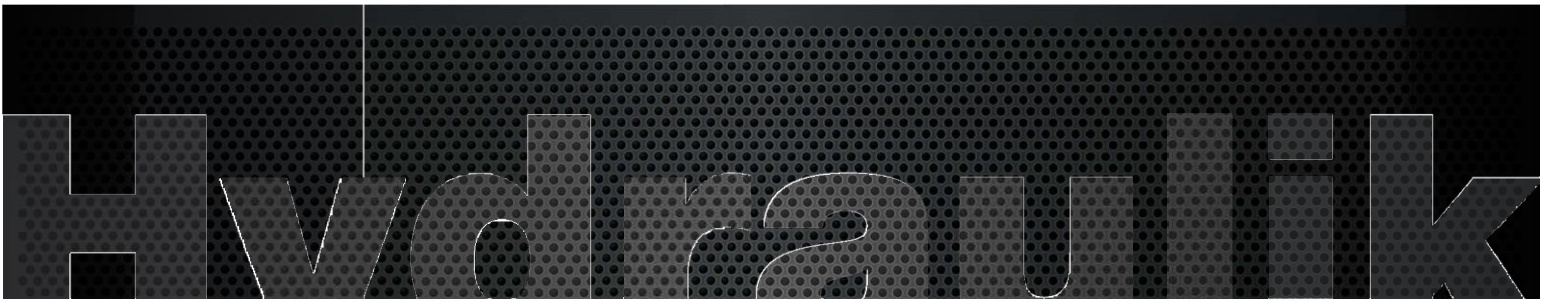

9. Anchor the pit channel

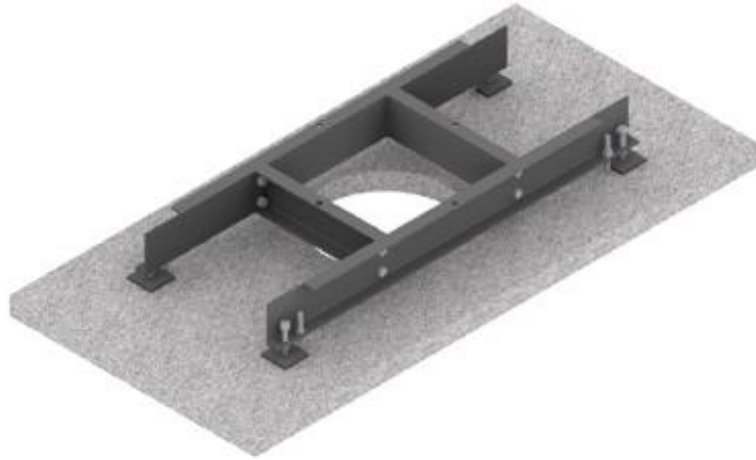

10. Install the pit channel into the concrete

Note: *It is recommended to cover the support in its totality, leaving only the superior ends uncovered.*

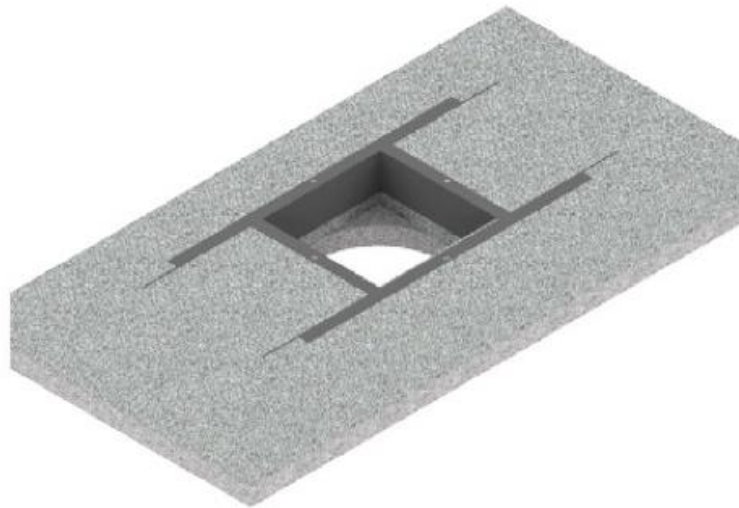

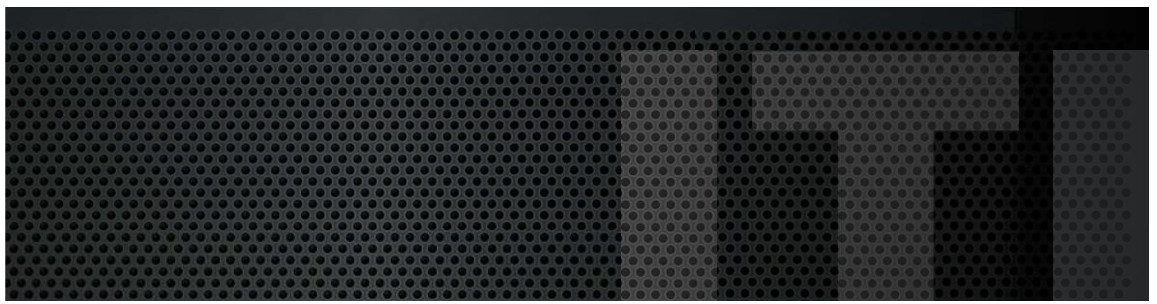
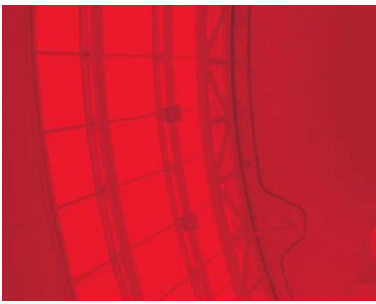

Warranty policy

GUARANTEE

1. ITI HYDRAULIK warrants to the original purchaser that this Product is free from any defects in materials or workmanship and agrees to repair or replace, in its sole discretion, any Product found to be defective during the period of **one year** from the date of delivery to the customer.
2. This warranty is only given to the original purchaser and comes into force on the delivery date of the Product.
3. The delivery date is the date of assumption of responsibility of the Product, ascertained by the bill of lading of the carrier.
4. Any part of this Product deemed, after reasonable evaluation by ITI HYDRAULIK, to be defective in workmanship or materials, will be repaired or replaced, free of charge for parts and labor, by ITI HYDRAULIK.

LIMITATION OF WARRANTY

5. This quality guarantee covers any defect in the manufacture or materials of the sold Product provided that:
 - (a) the Product is used for the purpose for which it is designed, intended and recommended by ITI HYDRAULIK;
 - (b) the Product has been installed and maintained by qualified personnel; and
 - (c) the maintenance recommended by ITI HYDRAULIK has been carried out by qualified personnel.
6. This warranty does not cover claims for damages, direct or indirect, for loss of time, or caused by a Product modification, Product tampering or Product adjustment made by or for the Buyer and not previously approved by ITI HYDRAULIK.
7. This warranty does not cover Product that has been damaged through abuse, neglected, lack of maintenance or failure to maintain the Product pursuant to the instructions in the user manual provided by ITI HYDRAULIK.
8. This warranty does not cover repairs necessitated by normal wear and tear of the Product or the use of unapproved parts and accessories with the Product or that are harmful to its proper functioning, performance or durability. In addition, this warranty excludes: consumable materials – hydraulic fluids, etc.
9. This warranty does not cover damage caused during transport, installation, maintenance or return of the Product. The Buyer shall promptly notify ITI HYDRAULIK in writing sent by mail, fax or registered mail when a defect is discovered, with a detailed explanation of the alleged defects. ITI HYDRAULIK will not assume and therefore will not pay any amount related to the elements mentioned above.
10. This warranty can not be relinquished, transferred or assigned to a third party; it is granted exclusively to the original purchaser of the Product. In the event that the Product is sold, transferred or otherwise disposed of, this warranty becomes void immediately for all legal purposes.

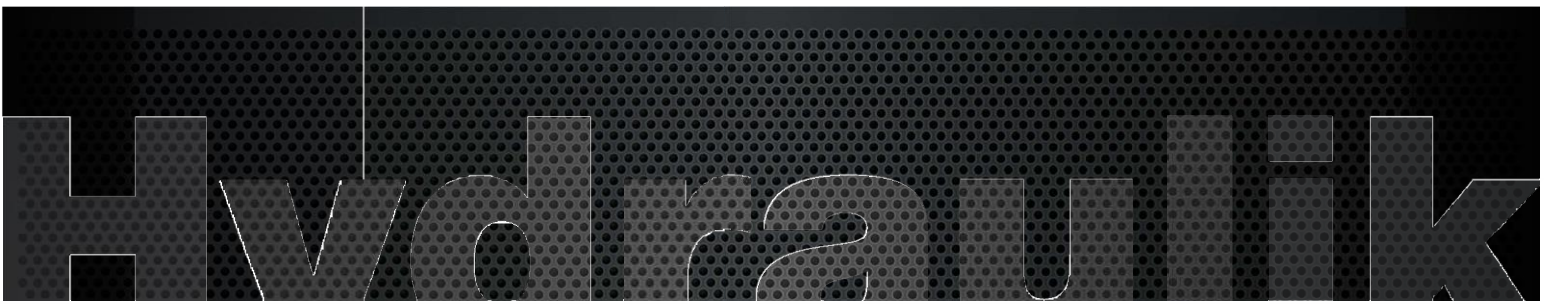

SUITABILITY OF THE PRODUCT

11. ITI HYDRAULIK complies with the manufacturing standards applicable to the Product sold. States and localities are governed by codes and regulations pertaining to construction, installation and use standards, which may differ from one region to another. ITI HYDRAULIK cannot be held responsible for the conformity of the Product with the application of these codes, standards, regulations; the Buyer is solely and exclusively responsible for this compliance before the confirmation of the order.

STORAGE OF THE PRODUCT

12. Storage of ITI HYDRAULIK products is not recommended for a period longer than 1 month; a horizontal position of the Product for a period of time greater than one month, may cause oil leakage. Any temporary storage requires a dry place, protected from theft, moisture, extreme heat and cold. Damage and defects caused by improper storage, stacking or handling are not covered by this warranty.

RETURNS OF MERCHANDISE

13. Any request to return the Product must be authorized prior to shipment by ITI HYDRAULIK Technical Services. Following an authorization from ITI HYDRAULIK, a return number is assigned and must be indicated on the outer packaging of the Product return packaging. The same packing criteria as at the original packing receipt must be utilized. The customer is responsible for transporting the return of the Product to the specified ITI HYDRAULIK factory. A Product found to be defective after inspection by ITI HYDRAULIK may, in our sole discretion, be repaired or replaced at no charge. A credit request for any product return must be authorized by ITI HYDRAULIK and is subject to a 35% restocking fee, plus initial shipping costs.

TECHNICAL SERVICE

14. ITI HYDRAULIK provides free installation manuals on its website and technical assistance on its Products. This information is intended for people with knowledge and skills in this area who will use it at their own risk. ITI HYDRAULIK assumes no liability for damage caused by anyone using these manuals.

PRICES OF PRODUCTS

15. Product prices are subject to change without notice.

FORCE MAJEURE

16. From the date of delivery, the buyer assumes all liability and costs inherent to the Product. ITI HYDRAULIK shall not be considered in default in the performance of its obligations hereunder if such performance is delayed, withheld or prevented as a result of a fortuitous event or force majeure. Force majeure is any cause that ITI HYDRAULIK could not reasonably have foreseen and against which it could not have protected itself. Force majeure includes, but is not limited to, any fortuitous event, injury, illness, accident, death, destruction of property, use of the Product sold, natural disaster, strike, partial or complete stoppage of work, lockout, fire, riot, intervention by civil or military authorities, acquiescence with the regulations or orders of any governmental authority and warfare (declared or not).

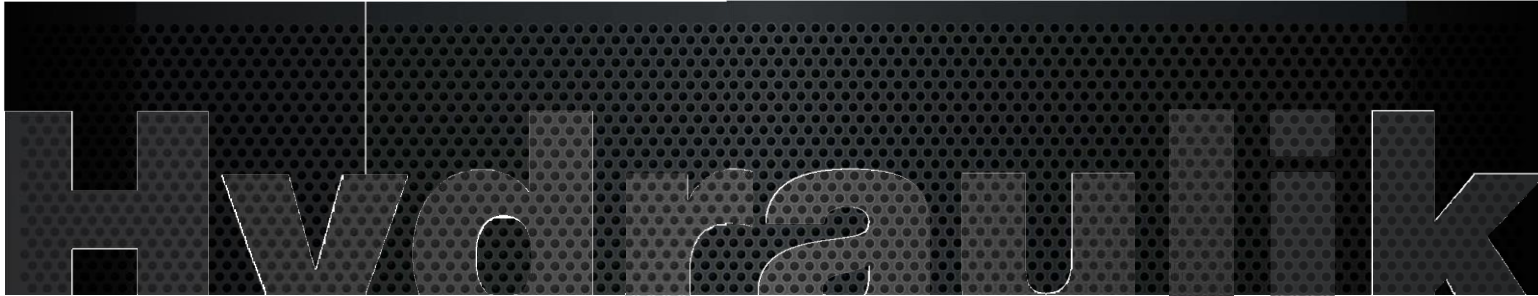

PRIORITY CLIENT

Since 20 years, the ITI engineers had access to tools and to state-of-the-art formations of the industry. It is this continues training that allows us to provide you with quality products that will meet your needs. Furthermore, we are the leaders regarding delivery deadlines.



3611 ROUTE 346, SAINTE-JULIENNE (QUÉBEC) J0K 2T0
TELEPHONE : 450-831-3229 | FAX : 450-831-2219 | TOLL FREE : 1-800-953-3229 | E-MAIL : INFO@ITIHIDRAULIK.COM

WWW.ITIHIDRAULIK.COM